

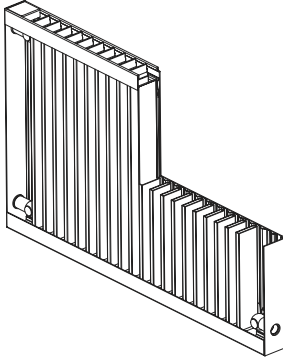

Plan - single



Plan single cutaway, rear view

Plan - double

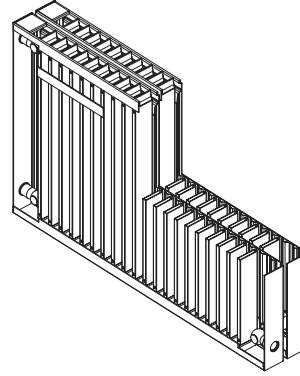

Plan double cutaway, rear view

Plan - single and double

Height and length

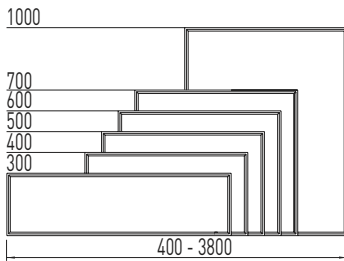

Plan single, profile

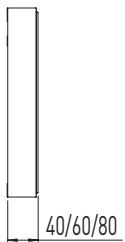

Plan double, profile

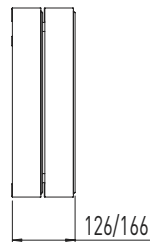

Weight max. 250 kg for Plan double

Plan - single and double with built-in valve

Built-in valve format 1

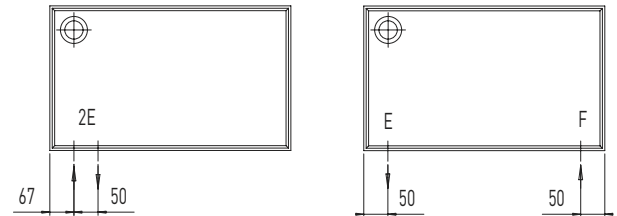

Built-in valve format 3

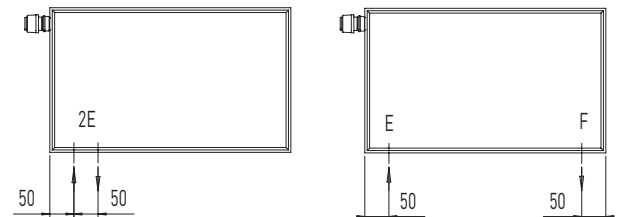

Built-in valve formats 1 and 3 can be delivered as follows:

- Downward facing tappings, 2E (left) or 2F (right)
- Downward facing tappings, EF
- Other options, please contact Hudevad

Length	Plan single and double: 400-3800 mm, with sections in increments of 33.33 mm
Height	Plan single and double: 300, 400, 500, 600, 700 and 1000 mm
Depth	Plan single: 40, 60 and 80 mm Plan double: 126 and 166 mm
Tappings	1/2" standard, adapter for 3/8" and 3/4"

Mounting	Wall or floor mounted Brackets are included Air vent is included
Colour	Powder coated in white RAL 9010 Option: Painted in other standard RAL and BS colours
Options	- Model UR-flex - Angled and curved - Horizon infill and end panel system - Console feet FH



Output - single

Plan single, depth 40 mm	Output		Water content litres/metre	Weight kg/metre
	Height mm	W/metre 75°/65°/20° 90°/70°/20°		
300	379	471	1.9	16.6
400	516	648	2.6	21.8
500	652	826	3.4	26.7
600	789	1004	4.1	31.5
700	925	1181	4.7	36.2
1000	1228	1571	7.0	51.5

Plan single, depth 60 mm	Output		Water content litres/metre	Weight kg/metre
	Height mm	W/metre 75°/65°/20° 90°/70°/20°		
300	457	569	2.7	20.5
400	621	782	3.7	27.0
500	786	1001	4.9	33.2
600	950	1212	5.9	39.3
700	1115	1425	7.0	45.3
1000	1480	1903	10.4	64.5

Plan single, depth 80 mm	Output		Water content litres/metre	Weight kg/metre
	Height mm	W/metre 75°/65°/20° 90°/70°/20°		
300	501	633	3.5	24.4
400	681	865	4.9	32.2
500	862	1106	6.4	39.7
600	1043	1339	7.8	47.1
700	1223	1572	9.3	54.4
1000	1623	2087	13.7	77.5

Output - double

Plan double, depth 126 mm	Output		Water content litres/metre	Weight kg/metre
	Height mm	W/metre 75°/65°/20° 90°/70°/20°		
300	767	962	5.4	41.0
400	1043	1312	7.5	54.0
500	1319	1648	9.8	66.5
600	1596	2019	11.9	78.6
700	1872	2397	14.0	90.6
1000	2485	3184	20.7	129.0

Plan double, depth 166 mm	Output		Water content litres/metre	Weight kg/metre
	Height mm	W/metre 75°/65°/20° 90°/70°/20°		
300	841	1039	7.0	48.8
400	1144	1413	9.8	64.4
500	1447	1791	12.8	79.5
600	1750	2186	15.7	94.1
700	2054	2584	18.5	108.8
1000	2726	3468	27.4	155.0

Build-in dimensions - single and double

Plan single, profile

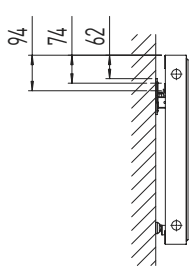

Plan double, profile

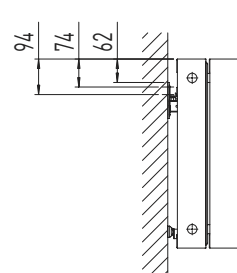

Tapping designation - single and double

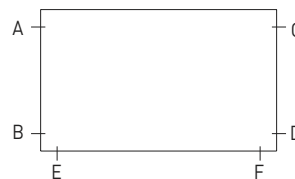

Tapping designation

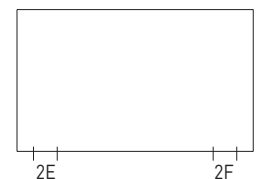

Tapping designation, 2E and 2F

Accessories - bracket

Bracket BP10/30

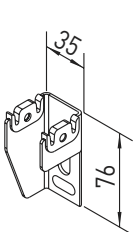

Spacer

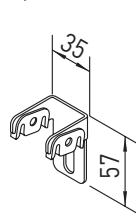
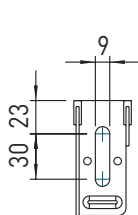

Accessories - feet

Adjustable console feet PR

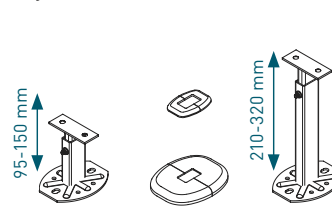

FDC feet

